

# Installation Guide for Econo Gravel Stop

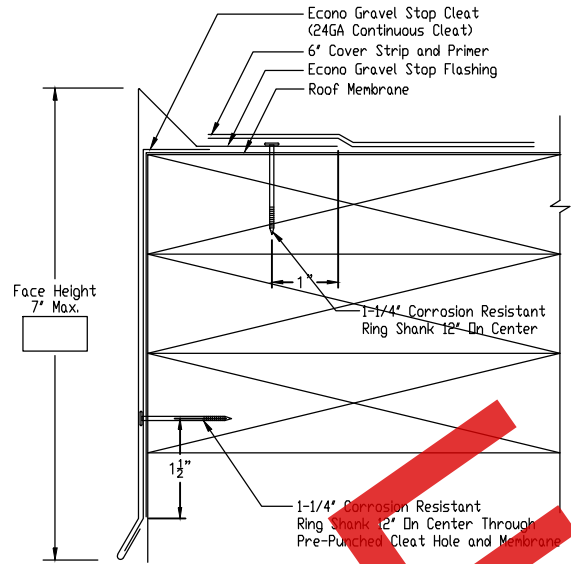

**NOTES:**  
 #1 - Isolate all metal parts from ACQ treated wood or other galvanically incompatible material with appropriate membrane material.  
 #2 - Appliance attachments, such as lightning rods, signs, or antennae that penetrate the water seal, induce a galvanic reaction, or otherwise compromise the effectiveness of the roof edge system, shall be eliminated or isolated to prevent problems per section 8.0 of ANSI/SPRI ES-1. Appliances should also be isolated from, or not attached to, the roof edge system. Consult the lightning protection system manufacturer for specific attachment instructions.

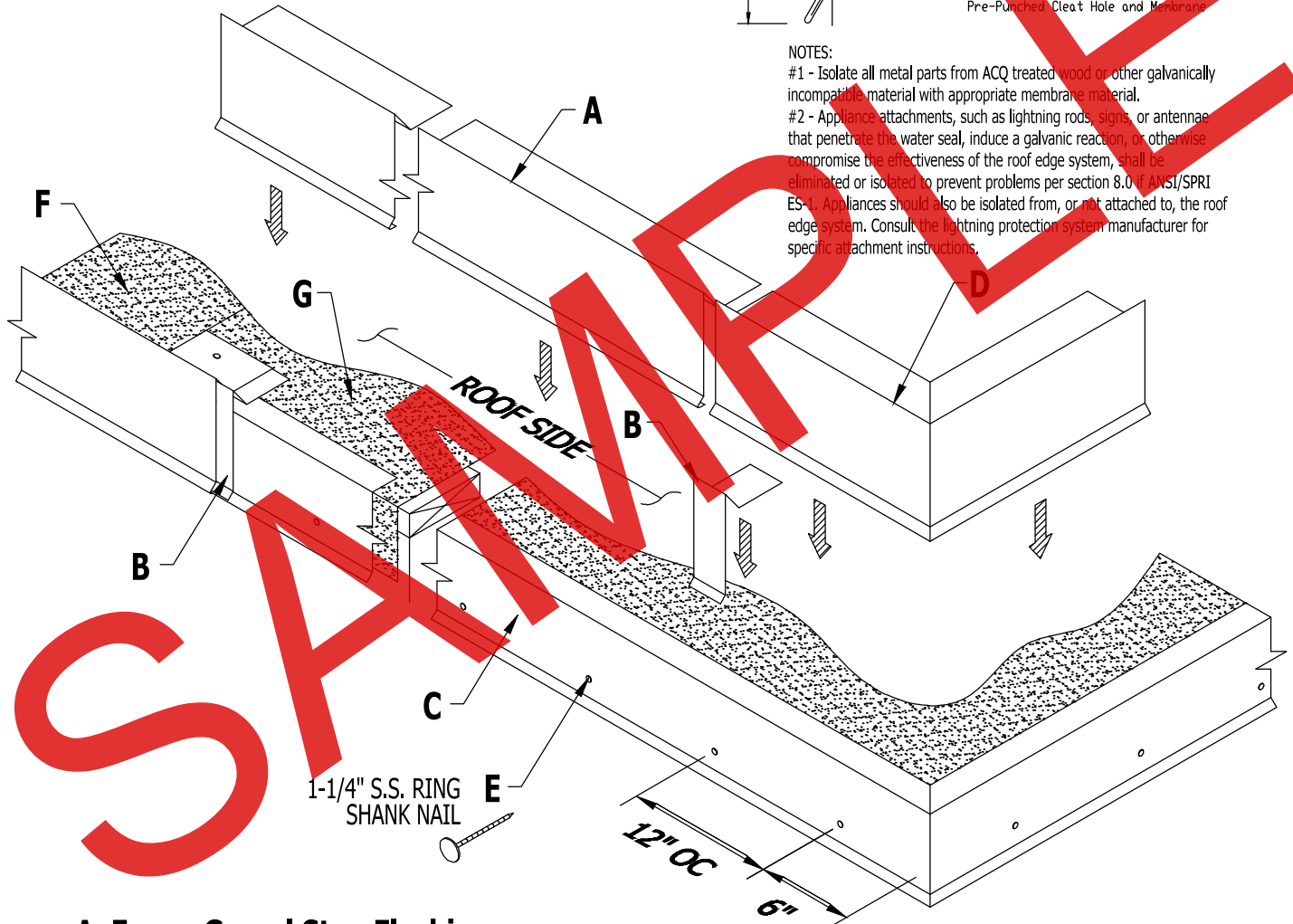

- A. Econo Gravel Stop Flashing**  
10'-0" Std. Lengths
- B. Econo Gravel Stop Splice Plate**  
6" Lengths
- C. 24GA Galvanized Continuous Cleat**  
10'-0" Lengths
- D. Econo Gravel Stop Miter**  
(Outside Corner Shown)

- E. 1-1/4" S.S. Ring Shank Nail**  
at 12" o.c. (6" from ends)  
(Included & Required)
- F. 6" Cover Strip**  
(By Installer)
- G. Approved Roofing Membrane**  
(By Installer)

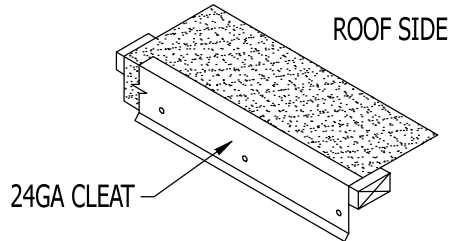

### STEP 1: Installing 24GA Galvanized Cleat

Place the top lip of the Cleat squarely on the top edge of the roofing membrane and treated wood nailing plate. Press Cleats securely in position and nail through the pre-punched holes with 1-1/4" S.S. Ring Shank Nails provided. For Miter application, fit into corner as required to maintain a continuous Cleat line. Then nail at a min. 6" in each direction from the corner or closer at special conditions.

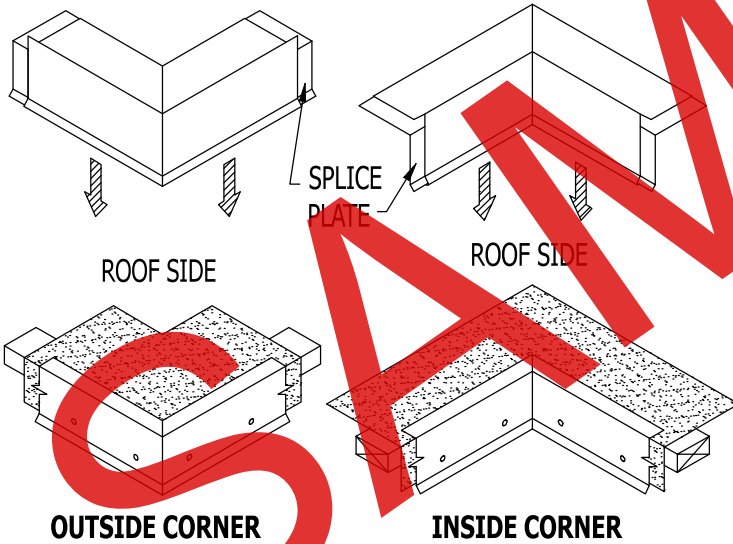

### STEP 2: Econo Gravel Stop Mitters

Locate the Miters and Splice Plates for the appropriate corners. Place a Splice Plate under each end of the Miter sections. Install the Miter by hooking the Econo Gravel Stop Miter onto the kick out of the Cleat, and rotate back onto the roof. Fasten with 1-1/4" S.S. Ring Shank nails provided at 12" on center maximum.

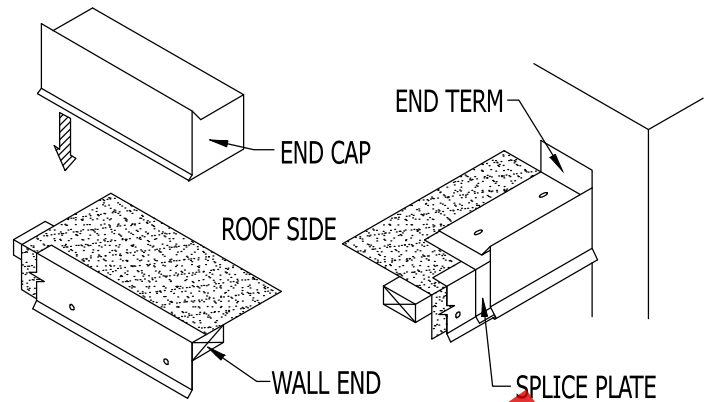

### STEP 3: Installing Econo Gravel Stop End Caps & Terms

Install the Econo Gravel Stop End Caps and End Terms by hooking the drip of the Econo Gravel Stop End Cap or Term onto the kick out of the Cleat and rotate back onto the roof. Fasten with 1-1/4" S.S. Ring Shank Nails provided at 12" on center maximum.

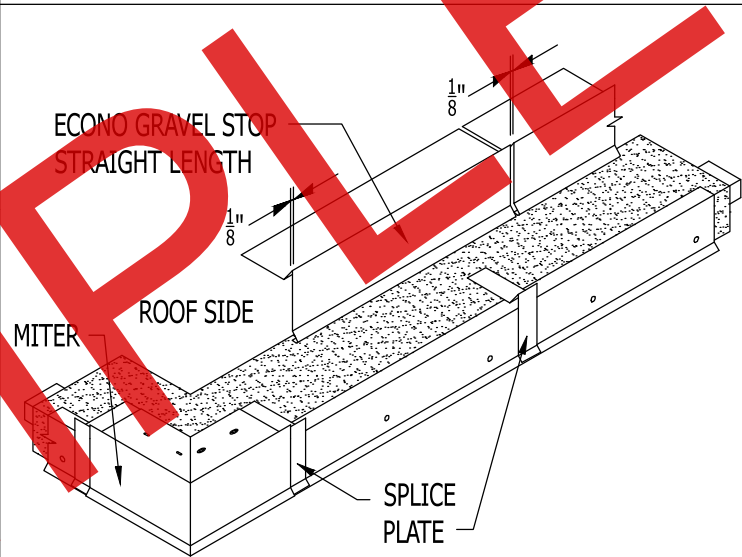

### STEP 4: Installing Econo Gravel Stop Straight Lengths

Place a Splice Plate in the opposite end of the installed Miter or End Cap. Install the Econo Gravel Stop by hooking the drip on to the kick out of the Cleat and rotate back onto the roof. Fasten with 1-1/4" S.S. Ring Shank Nails provided at 12" on center maximum. **Allow 1/8" Gap between Econo Gravel Stop lengths for thermal expansion.** Consider lengths of all straight pieces prior to cutting to avoid creating relatively short sections adjacent to one another. Note: There should be a Splice Plate at every joint.

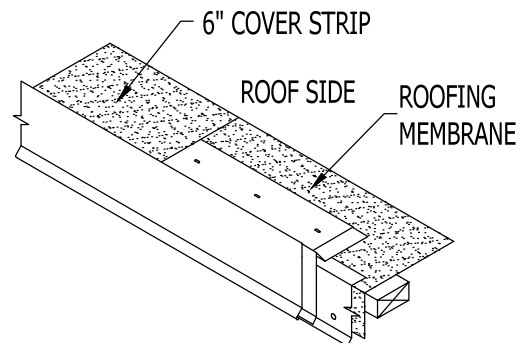

### STEP 5: Installing Approved Roofing Membrane

Install 6" Cover Strip per roofing manufacturer's instructions.