

DMC 175S - METAL DECK

NOTE:

- 1.) LAPS IN VALLEYWALL ARE 12" MIN. DREXEL METALS APPROVED SEALANT IN ALL LAPS IN VALLEY. TWO ROWS OF SEALANT BETWEEN VALLEYWALL LAPS, 4" UP FROM LAP.
- 2.) LARGE ROOF AREAS MAY REQUIRE A LARGER GAP BETWEEN PANEL AND WALL TO ALLOW FOR STORM WATER RUN OFF.

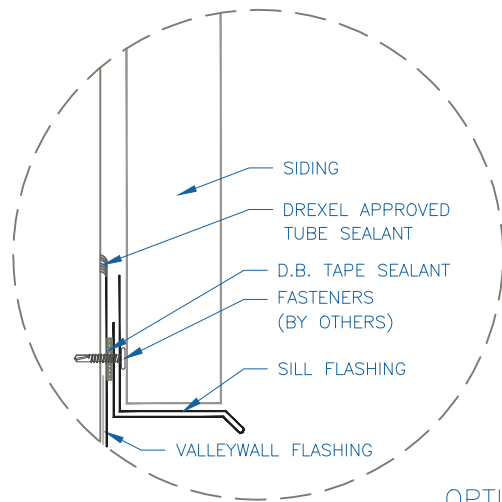
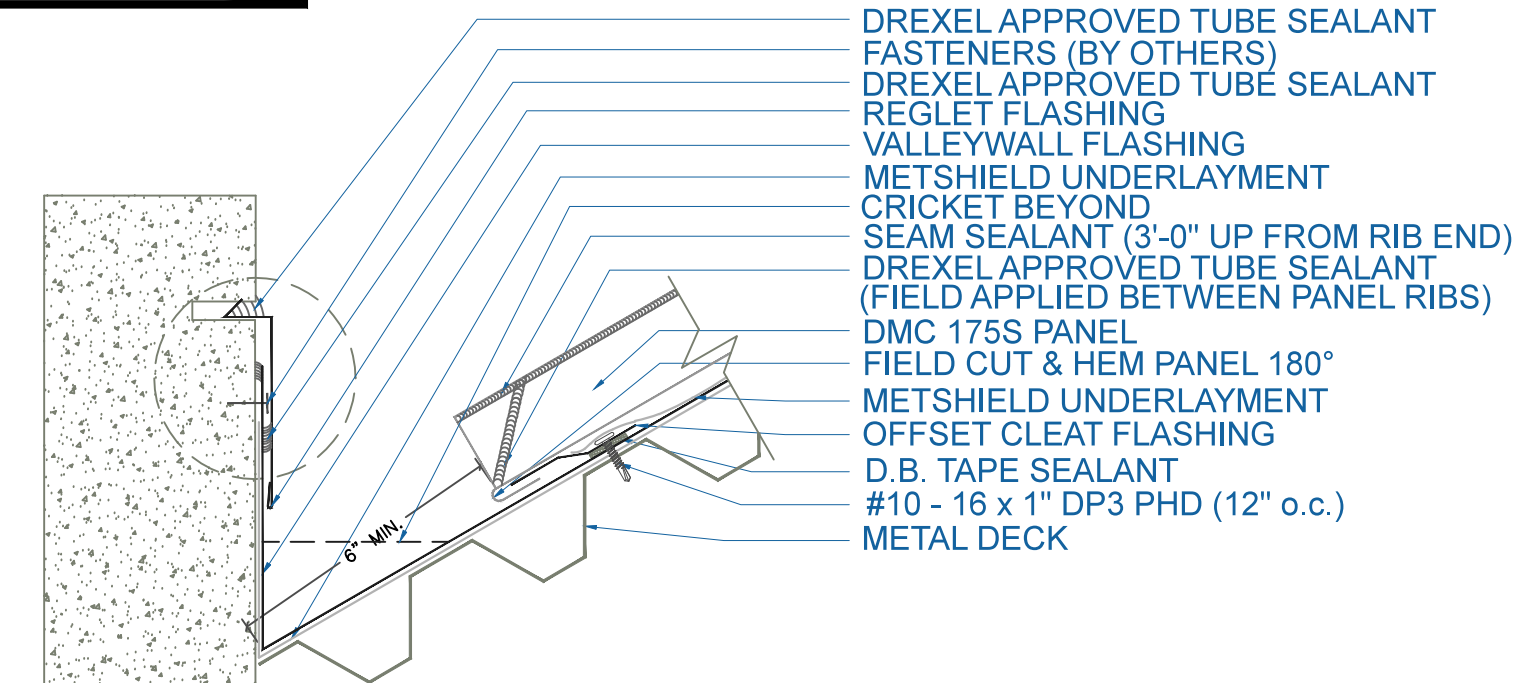

OPTION 1

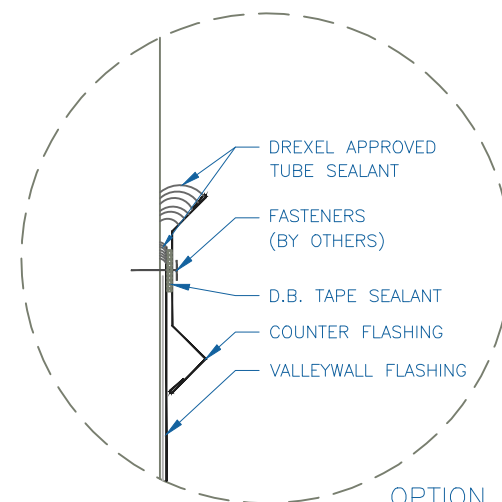

OPTION 2